

Cordex HP 2.4kW Switched Mode Rectifier System

Technical Guide: 0100003-J0

Effective: 07/2018



Cordex HP Modular Switched Mode Rectifier System

Shelf Models: 19" 1RU universal mount 9600W

23" 1RU universal mount 12000W

 **NOTE:**

Photographs contained in this manual are for illustrative purposes only. These photographs may not match your installation.

 **NOTE:**

Operator is cautioned to review the drawings and illustrations contained in this manual before proceeding. If there are questions regarding the safe operation of this powering system, contact Alpha Technologies or your nearest Alpha representative.

 **NOTE:**

Alpha shall not be held liable for any damage or injury involving its enclosures, power supplies, generators, batteries, or other hardware if used or operated in any manner or subject to any condition inconsistent with its intended purpose, or if installed or operated in an unapproved manner, or improperly maintained.

For technical support, contact Alpha Technologies:

Canada and USA: **1-888-462-7487**

International: **+1-604-436-5547**

Copyright

Copyright © 2018 Alpha Technologies Ltd. All rights reserved. Alpha is a registered trademark of Alpha Technologies.

No part of this documentation shall be reproduced, stored in a retrieval system, translated, transcribed, or transmitted in any form or by any means manual, electric, electronic, electromechanical, chemical, optical, or otherwise without prior explicit written permission from Alpha Technologies.

This document, the software it describes, and the information and know-how they contain constitute the proprietary, confidential and valuable trade secret information of Alpha Technologies, and may not be used for any unauthorized purpose, or disclosed to others without the prior written permission of Alpha Technologies.

The material contained in this document is for information only and is subject to change without notice. While reasonable efforts have been made in the preparation of this document to assure its accuracy, Alpha Technologies assumes no liability resulting from errors or omissions in this document, or from the use of the information contained herein. Alpha Technologies reserves the right to make changes in the product design without reservation and without notification to its users.

Table of Contents

1. Safety.....	5
1.1 Safety Symbols	5
1.2 General Safety	5
1.3 Mechanical Safety.....	5
1.4 Electrical Safety	6
1.5 Battery Safety	6
2. Introduction	7
2.1 Scope of the Manual	7
2.2 Product Overview.....	7
2.3 Part Numbers and List Options.....	8
3. Specifications.....	9
4. Product Features	11
4.1 Rectifier.....	11
4.2 Distribution	14
4.3 Controller	15
5. Inspection.....	16
5.1 Packing Materials.....	16
5.2 Check for Damage	16
5.3 General Receipt of Shipment.....	16
6. Installation.....	17
6.1 Safety Precautions.....	17
6.2 Tools Required	17
6.3 Power System Assembly and Mounting.....	18
7. Wiring.....	19
7.1 Installation Notes	19
7.2 Grounding	20
7.3 CAN Serial Ports (Rectifier Shelf).....	21
7.4 AC Wiring 23" Shelf.....	22
7.5 AC Wiring 19" Shelf.....	23
7.6 DC Output Connections - Bulk Distribution.....	24
7.7 DC Output Connections - Single Component Distribution	26

8. System Startup	27
8.1 Check System Connections.....	27
8.2 Verify AC and Power the Rectifier Shelf.....	27
8.3 Check Battery Polarity and Connections	27
9. Rectifier Modes and Factory Defaults.....	28
9.1 Rectifier Modes	28
9.2 Factory Ranges and Defaults	29
10. Maintenance	30
10.1 Replacing a Rectifier Module via the CXC HP Controller	30
10.2 Replacing a Rectifier Module via CXC Controller	31
10.3 Fan Replacement.....	32
11. Troubleshooting.....	34
12. Acronyms and Definitions	35
13. Warranty Statement and Service Information	36
13.1 Technical Support	36
13.2 Warranty Statement	36
13.3 Product Warranty	36
13.4 Battery Warranty	36
13.5 Warranty Claims.....	36
13.6 Service Information	36
14. Certification	37

List of Figures

- Figure 1 — Cordex HP 19" 48Vdc-2.4kW Rectifier Shelf 7
- Figure 2 — Typical 48V Power System with 2.4kW Rectifiers 7
- Figure 3 — Rectifier Front Panel LEDs..... 11
- Figure 4 — Locking Handle Disengaged/Engaged 13
- Figure 5 — 23" or 19" Shelf with Bulk Distribution Busbars..... 14
- Figure 6 — 19" Shelf with Single Component Distribution..... 14
- Figure 7 — CXPS-E3 System containing 2.4kW Shelf and CXC HP Controller 15
- Figure 8 — Chassis Ground 18
- Figure 9 — CAN Bus Cabling 21
- Figure 10 — AC Input and Ground for 23" Shelf..... 22
- Figure 11 — Positive and Negative Output Bars on 23" and 19" Bulk Distribution Models 24
- Figure 12 — Connecting Output Bars to Customer's Vertical Busbars..... 25
- Figure 13 — Connecting Output Bars Directly to Cables..... 25
- Figure 14 — 19" Shelf in with Single Component Distribution 26
- Figure 15 — Rectifier Bottom View..... 32
- Figure 16 — Removing Front Panel from Rectifier 32
- Figure 17 — Reattaching the Front Panel 33
- Figure 18 — 2.4kW Rectifier Fan Assembly 33
- Figure 19 — Locking the Front Panel in Place 33

1. Safety

SAVE THESE INSTRUCTIONS: This manual contains important safety instructions that must be followed during the installation, servicing, and maintenance of the product. Keep it in a safe place. Review the drawings and illustrations contained in this manual before proceeding. If there are any questions regarding the safe installation or operation of this product, contact Alpha Technologies or the nearest Alpha representative. Save this document for future reference.

1.1 Safety Symbols

To reduce the risk of injury or death, and to ensure the continued safe operation of this product, the following symbols have been placed throughout this manual. Where these symbols appear, use extra care and attention.

The use of **ATTENTION** indicates specific regulatory/code requirements that may affect the placement of equipment and /or installation procedures.



NOTE:

A NOTE provides additional information to help complete a specific task or procedure. Notes are designated with a check mark, the word NOTE, and a rule beneath which the information appears



CAUTION!

CAUTION indicates safety information intended to PREVENT DAMAGE to material or equipment. Cautions are designated with a yellow warning triangle, the word CAUTION, and a rule beneath which the information appears.



WARNING!

WARNING presents safety information to PREVENT INJURY OR DEATH to personnel. Warnings are indicated by a shock hazard icon, the word WARNING, and a rule beneath which the information appears.



HOT!

The use of HOT presents safety information to PREVENT BURNS to the technician or user.

1.2 General Safety



WARNING!

This system is designed to be installed in a restricted access location that is inaccessible to the general public.

1.3 Mechanical Safety

- Keep hands and tools clear of fans. Fans are thermostatically controlled and switch on automatically.
- Power supplies can reach extreme temperatures under load.
- Use caution around sheet metal components and sharp edges.

1.4 Electrical Safety



WARNING!

Hazardous voltages are present at the input of power systems. The DC output from rectifiers and batteries, though not dangerous in voltage, has a high short-circuit current capacity that may cause severe burns and electrical arcing.

- Before working with any live battery or power system, follow these precautions:
 - a. Remove all metallic jewelry, such as watches, rings, metal rimmed glasses, or necklaces.
 - b. Wear safety glasses with side shields at all times during the installation.
 - c. Use OSHA approved insulated hand tools.



WARNING!

Lethal voltages are present within the power system. Always assume that an electrical connection or conductor is energized. Check the circuit with a voltmeter with respect to the grounded portion of the enclosure (both AC and DC) before performing any installation or removal procedure.

- Do not work alone under hazardous conditions.
- A licensed electrician is required to install permanently wired equipment. Input voltages can range up to 277Vac nominal. Ensure that the utility power is disconnected and locked out before performing any installation or removal procedure.
- Ensure that no liquids or wet clothes come into contact with internal components.
- Hazardous electrically live parts inside this unit are energized from the batteries even when the AC input power is disconnected.

1.5 Battery Safety

- Servicing and connection of batteries must be performed by, or under the direct supervision of, personnel knowledgeable of batteries and the required safety precautions.
- Always wear eye protection, rubber gloves, and a protective vest when working near batteries. Remove all metallic objects from your hands and neck.
- Use OSHA approved insulated hand tools. Do not rest tools on top of batteries.
- Batteries contain or emit chemicals known to cause cancer and birth defects or other reproductive harm. Battery post terminals and related accessories contain lead and lead compounds. Wash your hands after handling batteries.



WARNING!

Follow battery manufacturer's safety recommendations when working around battery systems. Do not smoke or introduce an open flame when batteries (especially vented batteries) are charging. When charging, batteries vent hydrogen gas, which can explode.

- Batteries are hazardous to the environment and should be disposed at a recycling facility. Consult the battery manufacturer for recommended local authorized recyclers.

2. Introduction

2.1 Scope of the Manual

This manual explains the installation, interconnection, and operation of the Cordex HP 48-2.4kW rectifier systems.

2.2 Product Overview

A complete rectifier system consists of one or more power modules in a common shelf enclosure. The shelf has connections for AC inputs, DC output, and system communications. The wide AC input operating range for global installations and wide operating temperature ranges for installation in uncontrolled environments along with high efficiency (>96%) reduces the carbon footprint and the operating expenses.

Cordex rectifier modules use a high frequency, switched mode conversion technique to provide a fully regulated and isolated DC output from the AC mains. Multiple 48V configurations are available up to 250A in a compact 1RU shelf system. Industry leading power density (28W/in³) yields more space for revenue generating equipment.

Rectifier power modules are “hot swappable”—they can be inserted or removed from the shelf without cutting power to or from the system or the load. Additional power modules can be included with the system at the time of ordering or added after the shelf has been installed.

The shelf rectifier system is designed to operate with the Alpha Cordex System Controller (CXC). This controller allows the user to configure, monitor and control the entire DC power system from its touch screen display which includes temperature compensation, auto equalization, remote access, dial out on alarm, battery diagnostics, as well as Web server and SNMP support for configuration and monitoring. Details of controller operation are provided in the current version of the related software manual.

External CXC models of the system controller communicate with the shelf via RJ-12 shelf connectors. In a power system, up to five (5) rectifier shelves may be stacked and connected to the same controller. The latest CXC-HP controller, featuring touch screen, color LCD display with front Ethernet and USB connectors, is available as a panel mount controller or as part of the CXPS-E3 system.



Figure 1 — Cordex HP 19" 48Vdc-2.4kW Rectifier Shelf



Figure 2 — Typical 48V Power System with 2.4kW Rectifiers

2.3 Part Numbers and List Options

The product, options, and accessories can be ordered by using the part numbers in the following table.

Description	List Option
23in 1RU universal mount 12000W shelf* – bulk power for external distribution – up to five Cordex HP 2.4kW rectifiers	0300057-001
19in 1RU universal mount 9600W shelf* – bulk power for external distribution – up to four Cordex HP 2.4kW rectifiers	0300040-001
19in 1RU universal mount 9600W shelf* – separate feed In/Out, – up to four Cordex HP 2.4kW rectifiers	0300040-002
Cordex HP 2.4kW rectifier	0100003-001
Fan assembly replacement	7400374-001
Module blank	7400424-001
Rear DC Output 19" shelf cover	0370250-001
Rear DC Output 23" shelf cover	0370250-002

*Note: Standard DC bus bars available up to a maximum of five shelves per system.

3. Specifications

Table A — 2.4kW Rectifier Specifications	
Electrical	
Input voltage:	
Nominal:	208 to 277Vac
Operating:	90 to 310Vac
Extended:	90 to 187Vac (de-rated power)
Input frequency:	44 to 66Hz
Power:	2400W continuous
	(1200W output @ 120Vac Input)
Power Factor:	>0.99 (50 to 100% load)
THD:	<5%
Efficiency:	96.2% peak
Output Voltage:	42 to 58Vdc (No load 46.5 to 58Vdc)
Output Current:	44.5A @ 54Vdc (50A max @ 48Vdc)
	(~25A @ 48Vdc at 120Vac Input)
Load regulation:	<±0.7% (static)
Line regulation:	<±0.1% (static)
Transient response:	±3% for 40 to 90% load step
Noise:	
Voice band:	<38dBmC
Wide band:	<20mV RMS (10kHz to 10MHz)
	<150mV peak to peak (10kHz to 100MHz)
Psophometric noise:	<2mV RMS
Acoustic:	<60dBa @ 1m (3ft), 30°C
MTBF:	627,000 hours (71 years) per Telcodia SR332 - Issue 3 (2011)
Mechanical	
Dimensions H x W x D:	41mm x 104mm x 333mm (1.6in x 4.1in x 13.1in)
Weight:	1.76kg (3.9lbs)
Environmental	
Temperature:	
Operation:	-40 to 75°C (-40 to 149°F)
Full Nominal Output Power:	-40 to 55°C (-40 to 131°F); >2000W @ 65°C (167°F)
Storage:	-40 to 85°C (-40 to 185°F)
Humidity:	0 to 95% RH non-condensing
Heat Dissipation:	<350 BTU per hour (typical)
	<500 BTU per hour (worst case: 100% load at 187 Vac)

3.3.1 Cordex 48-2.4kW Rectifier Shelves

23in 1RU universal mount 12,000W shelf P/N 0300057-001	
Number of Rectifiers:	5 x CXRF HP 48-2.4kW
Nominal AC input current (two modules per feed):	120VAC/23A (per feed), 50/60Hz 208-277VAC/25A (per feed), 50/60Hz
Recommended input feeder breakers (three feeds per shelf):	40A per feed for nominal 120, 208, 240, 277 Vac
Recommended AC input wire size:	8 AWG line; 10 AWG Protective Earth
Shelf output power:	12kW maximum
Distribution:	Bulk power for external distribution
Dimensions, H x W x D:	44mm x 537mm x 420mm (1.75in x 21.1in x 16.5in)
Weight:	5.7kg (12.6lbs)
Communications ports:	CAN: interface to control rectifiers & smart peripherals
19in 1RU universal mount 9600W shelf P/Ns 0300040-001/002	
Number of Rectifiers:	4 x CXRF HP 48-2.4kW
Nominal AC input current (one module per feed):	120VAC/11.5A (per feed), 50/60Hz 208-277VAC/12.5A (per feed), 50/60Hz
Recommended input feeder breakers (four feeds for shelf):	20A per feed for nominal 120, 208, 240, 277 Vac
Recommended AC input wire size:	12 AWG line; 14 AWG protective earth
Shelf output power:	9.6kW maximum
Distribution Options:	Bulk power for external distribution (0300040-001) Separate feed In/Out (0300040-002)
Dimensions, H x W x D:	44mm x 438mm x 420mm (1.75in x 17.3in x 16.5in)
Weight:	4.5kg (9.9lbs)
Communications ports:	CAN: interface to control rectifiers & smart peripherals
Agency Compliance	
Safety:	CSA 60950-1-07 UL 60950-1 IEC 60950-1 EN 60950-1 CE marked
EMC:	ETSI EN 300 386
Emissions:	CFR47 (FCC) Part 15 Class A EN 55022 (CISPR 22) Class A EN 61000-3-2 EN 61000-3-3
Immunity:	EN 61000-4-2 EN 61000-4-3 EN 61000-4-4 EN 61000-4-5 EN 61000-4-6 EN 61000-4-11 Designed to meet ANSI / IEEE C62.41 CatB3

4. Product Features

4.1 Rectifier

4.1.1 Front Panel LEDs

The front panel LEDs indicate the rectifier status summary and patterned response to Locate Module command.

ALARM / FAULT (1)

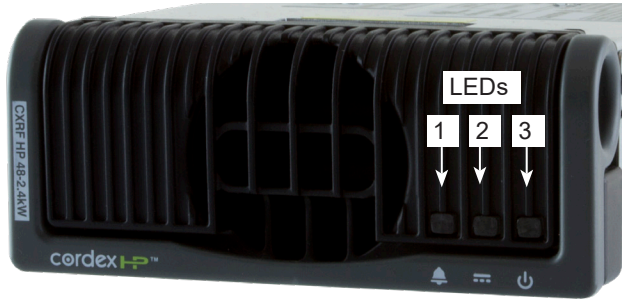

Figure 3 — Rectifier Front Panel LEDs

The red LED is on during an active Module Fail alarm if the module is unable to source power due to a fault condition. Refer to the relevant controller manual for fault details.

The LED flashes (~2Hz) when a minor alarm is detected if the modules output capability has been reduced or a minor failure is detected.

DC ON (2)

The green LED is on when the rectifier is delivering power to the load. The LED goes out when the rectifier is off. For example, when commanded by the CXC.

AC ON (3)

The green LED is on when the AC input voltage is qualified and within the specified range 90Vac to 310Vac and frequency 44 to 66 Hz.

LED Activity During the Locate Module Command from CXC

The **Locate Module** command from the CXC, causes the LEDs of the target rectifier to flash in a cyclical pattern. This flashing normally lasts 60 seconds.

LED Activity During Power Save

When a rectifier is put into power save mode, only the AC ON LED remains illuminated.

4.1.2 Rectifier Rear Panel

Refer to drawings at the end of this manual for shelf power and communications connections:

- 0300057-08
- 0300040-08

4.1.3 True Module Fail Alarm

The power modules have a “true” fail alarm that provides a true indication of the power module’s ability to source current. When the module’s output current drops below 2.5% of the rated output, a low output current condition is detected and the Module Fail detection circuit is activated. This circuit momentarily ramps up the output voltage to determine if the module will source current. If no increase in current is detected, the **Module Fail** alarm is activated. The module will test once every 60 seconds for the condition until a current is detected. The output voltage ramping ceases upon detection of current. A minimum 2.5% load is required to avoid the **Ramp Test Fail** alarm. This load can be provided with the parallel system battery. Activation of this alarm could indicate a failed module or a failed load.

To avoid nuisance alarms for Cordex rectifier systems without batteries, and/or with a very light load (below 2.5% of the rated output), the ramp test should be disabled. Disable the Ramp Test via the CXC menu: **System > DC System > Inventory > Rectifiers > Configuration**.

4.1.4 Heat Dissipation

Each rectifier module is equipped with a front-mounted, variable-speed fan. The fan speed is determined based on ambient temperature, rectifier temperature and the load. Air flow is front-to-rear with the exhaust air exiting through internal vents at the rear of the unit.

4.1.5 Over Temperature Protection

Blockage or obstruction to the air flow can result in the internal temperature to rise and reduce the output power or even shut down the rectifier. The rectifier will resume normal operation when the temperature reduces to a safe level. Over temperature shut down can also occur when a fan failure has occurred.

4.1.6 Wide AC Range

The rectifier delivers up to 2400W of power between 187 Vac and 310 Vac input voltage. The rectifier can deliver up to 1200W between 90 Vac and 187 Vac.

During start up the rectifier begins to provide power for input voltage >95 Vac and shuts down if the input voltage drops below 85 Vac. The THD and power factor will be out of specs for input >277 Vac.

4.1.7 AC Inrush/Transient Suppression

To prevent a surge on the AC input line, the inrush current of a rectifier module is limited to the full load steady state line current. Modules are also protected from input lightning and transient surges in accordance with IEEE/ANSI C62.41 Category B3 standards.

4.1.8 Soft Start

A soft start feature is used to eliminate an instantaneous demand on the AC power source. A soft start, sometimes referred to as a “current walk-in”, works by gradually (up to five seconds) ramping up the DC output current limit from zero to the actual or defined customer setting. The rectifier output voltage is ramped from the minimum voltage to the float voltage.

This feature along with Start Delay (4.1.9) prevents any instantaneous surge demand from the utility.

4.1.9 Start Delay

The rectifier modules are equipped with a delay timer to stagger-start a series of modules. When multiple modules and multiple shelves, part of a larger system are used in conjunction with a controller, a start delay prevents all rectifiers from starting at the same time and causing an inrush on the utility. The default start delay is set to 1 second and can be adjusted up to 250 seconds on the CXC HP controller. The built-in timer delays the switching on of the module by the start delay interval (up to 250 seconds), which is set in the CXC.

4.1.10 Current Limit/Short Circuit Protection

The current limit function determines the maximum output current limit of the rectifier module, regardless of the output voltage or power. The maximum output current is limited to a constant value down to a short circuit condition. Current limiting can be used to mate the rectifier output current ampacity to the needs of the load and parallel battery to minimize excessive battery recharge currents.

The rectifier will sustain a continuous short circuit at the output terminals. The maximum short circuit current will not exceed 50A per module.

4.1.11 Power Limiting

Each rectifier module is designed to limit the power output to the module specification. This enables more current to be supplied at lower output voltages, and allows matching the output power to the demands of constant-power loads often seen in telecom equipment.

This feature can also be used for a faster recharge of flooded batteries paralleled with the load.



NOTE:

The current limiting feature overrides the power-limiting feature.

4.1.12 High Voltage Shutdown (HVSD)

This feature protects the load from over-voltages originating in the rectifiers. The offending rectifier module is shut down when a high output voltage condition occurs. The red Alarm (Module Fail) LED will illuminate. The module will restart automatically. However, if more than three over-voltage conditions occur within one minute, the module will latch off and remain shut down until it is reset by restarting the rectifier via the CXC.

4.1.13 Battery Eliminator Operation

Rectifier modules maintain all specifications (except where indicated) with or without a battery or a DC source attached in parallel to the output. Under these conditions there will be no monitoring or control activity if AC power failure occurs.

4.1.14 Mechanical

An integral handle provides a means to both insert and remove the rectifier as well as locking the rectifier in place.

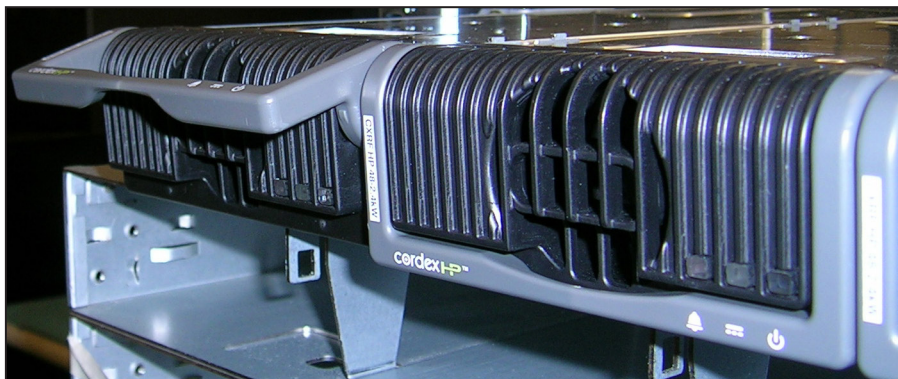

Figure 4 — Locking Handle Disengaged/Engaged

4.2 Distribution

4.2.1 Bulk

- 23in 1RU universal mount 12,000W P/N 0300057-001
- 19in 1RU universal mount 9,600W P/N 0300040-001

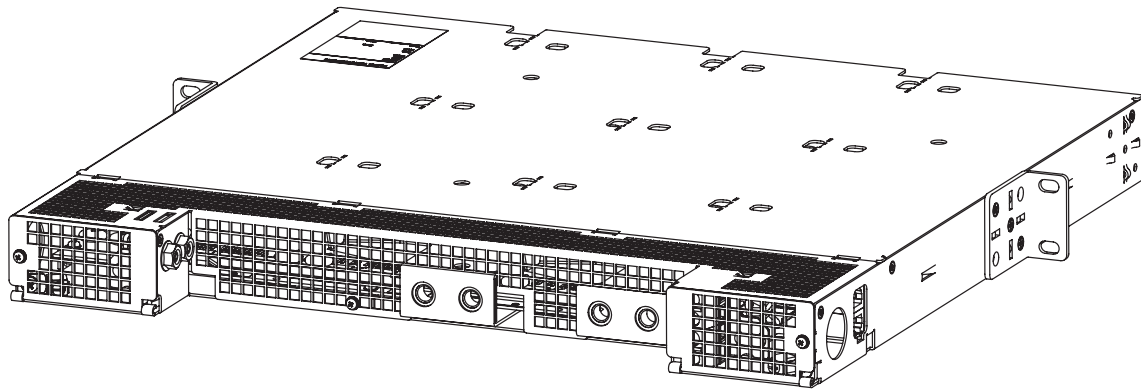

Figure 5 — 23" or 19" Shelf with Bulk Distribution Busbars

4.2.2 Separate feed In/ Out

- 19in 1RU universal mount 9,600W P/N 0300040-002

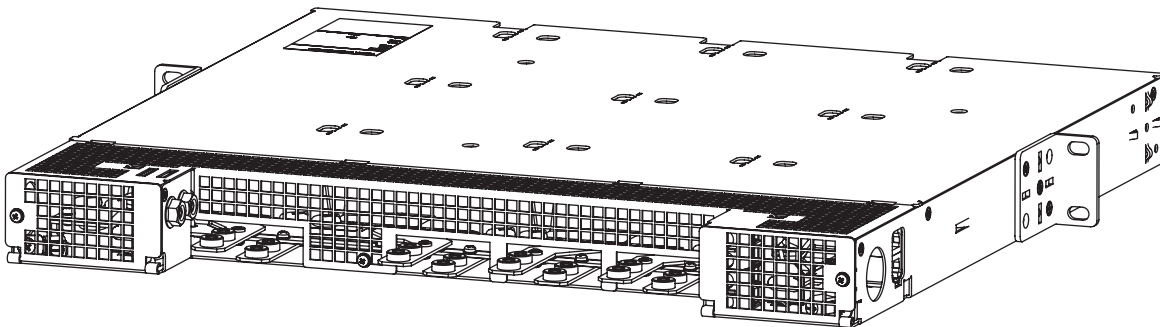

Figure 6 — 19" Shelf with Single Component Distribution

4.3 Controller

The 2.4kW rectifier shelf is designed to operate with the CXCR/CXCP controller (panel/rack) or the CXC HP controller. A controller adds the following capabilities to the rectifiers:

- Local and remote communications and monitoring
- User definable alarms
- Daily logging of events and system statistics
- Load sharing
- Power Save



Figure 7 — CXPS-E3 System containing 2.4kW Shelf and CXC HP Controller

NOTE:
The 2.4 kW shelf is also designed to operate without a Cordex controller; however load balancing among the rectifiers won't be as efficient, particularly at lower input voltages.

4.3.1 Internal CAN Bus

A CAN bus is used to transmit all alarm and control functions between the controller and rectifier shelves. Two CAN serial ports (modular jacks), are located on the left side of the rectifier shelf as viewed from the front.

The CAN bus can be daisy-chained from shelf to shelf (CAN 1 of one shelf to CAN 2 of another). The last shelf is terminated using a CAN terminator – "Figure 9 — CAN Bus Cabling" on page 21



5. Inspection

5.1 Packing Materials







Alpha is committed to providing products and services that meet our customers' needs and expectations in a sustainable manner, while complying with all relevant regulatory requirements. As such Alpha strives to follow our quality and environmental objectives from product supply and development through to the packaging for our products.

Rectifiers and batteries are shipped on individual pallets and are packaged according to the manufacturer's guidelines.

Almost all of Alpha's packaging material is from sustainable resources and or is recyclable. See the following table for the material and its environmental codes.

5.1.1 Returns for Service

Save the original shipping container. If the product needs to be returned for service, it should be packaged in its

 PAP/PCB	 PET	 PE-LD	 PS	 FE	 ALU	 NW
Cardboard	Polyethylene Terephthalate	Low Density Polyethylene	Polystyrene	Steel	Aluminum	Wood
Packing boxes Caps	Flexible film Packaging	Bubble wrap Shrink wrap Plastic bags	Foam	Strapping on pallets	Strapping on pallets	Pallets Lumber

original shipping container. If the original container is unavailable, make sure that the product is packed with at least three inches of shock-absorbing material to prevent shipping damage.

NOTE:

Alpha Technologies is not responsible for damage caused by improper packaging of returned products.

5.2 Check for Damage

Before unpacking the product, note any damage to the shipping container. Unpack the product and inspect the exterior for damage. If any damage is observed, contact the carrier immediately. Continue the inspection for any internal damage. In the unlikely event of internal damage, inform the carrier and contact Alpha Technologies for advice on the impact of any damage.

5.3 General Receipt of Shipment

The inventory included with your shipment depends on the options you have ordered. The options are clearly marked on the shipping container labels and bill of materials.

5.3.1 Shelves

Consult the packing slip and power system bill of materials to verify that you have the correct number of shelves per your order.

5.3.2 Rectifiers (Purchased Separately)

Consult the packing slip to verify that you have received the correct number of rectifiers per your order.

5.3.3 Miscellaneous Small Parts

Review the packing slip and bill of materials to determine the part number of the "configuration kits" included with your system. Review the bill of materials to verify that all the small parts are included.

6. Installation

The equipment is suitable for installation in Network Telecommunication Facilities.



WARNING!

This system is designed to be installed in a restricted access location that is inaccessible to the general public.

The following procedure is written for qualified personnel to install this product in a clean and dry environment. For the battery installation, refer primarily to the manufacturer's manual.

6.1 Safety Precautions

Refer to section "1. Safety" on page 5 before beginning this installation.

6.2 Tools Required

Various insulated tools are essential for the installation. Use this list as a guide:

- Battery lifting apparatus if required
- Electric drill with hammer action, 1/2" capacity
- Various crimping tools and dies to match lugs used in installation
- Load bank of sufficient capacity to load largest rectifier to its current limit
- Digital voltmeter equipped with test leads
- Cable cutters
- Torque wrench: 1/4" drive, 0 - 150 in-lb
- Torque wrench: 3/8" drive, 0 - 100 ft-lb
- Insulating canvases as required (1' x 1', 2' x 2', 3' x 3', etc.)
- Various insulated hand tools including:
 - Combination wrenches - Ratchet and socket set
 - Various screwdrivers. - Electricians knife
- Battery safety spill kit required for wet cells only:
 - Protective clothing - Face shields
 - Gloves - Baking soda
 - Eye wash equipment
- Cutters and wire strippers (#14 to #22 AWG) [2.5 to 0.34 mm²]

6.3 Power System Assembly and Mounting

6.3.1 Mounting and Grounding a Rectifier Shelf



NOTE:

Mount the shelf in a clean and dry environment. Allow at least 1.75" of free space in front of the unit for unrestricted cooling airflow. Sufficient free space must be provided at the front and rear of the power system. This is to meet the cooling requirements of the rectifiers and to allow easy access to the power system components.

The 19" and 23" shelves have been designed for mid mounting in a standard EIA relay rack. Mounting brackets accommodate either 1" or 1-3/4" rack spacing.

Options for flush mounting in a 19" or 23" rack are also available, but require additional mechanical support at the rear of the unit unless connected to bus bars

1. Mount the shelf to the customer-provided rack using at least two #12 – 24 x 1/2" screws in each bracket. Use Phillips type screws and screwdriver to eliminate the possibility of slippage and scratching of the unit's exterior.
2. Connect the shelf chassis ground (Figure 8) to the rack. On the rack, use thread-forming screws and star washers that remove any paint or non-conductive coatings and establish metal-to-metal contact to ensure a proper electrical bond.

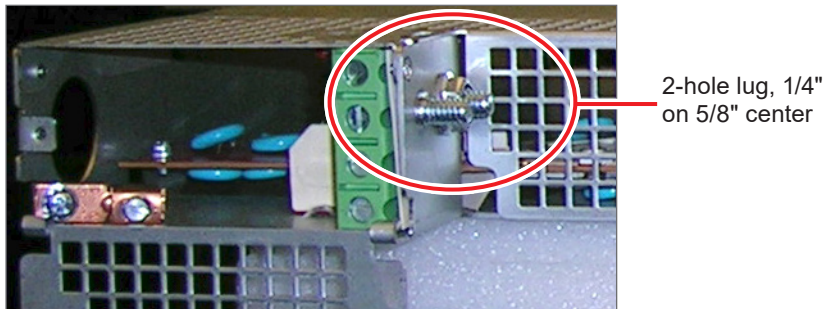

Figure 8 — Chassis Ground

6.2.1 Power System Size

In a power system, up to five (5) rectifier shelves may be stacked and connected to the same controller.

7. Wiring

This chapter provides cabling details and notes on cable sizing for DC applications with respect to the product.



WARNING!

Ensure that the power is switched off by switching off rectifiers and removing battery line fuses, turn off battery breakers before attempting work on the wiring. Use a voltmeter to verify the absence of a voltage. Clearly mark the correct polarity of the battery leads before starting work on DC connections.

7.1 Installation Notes

Refer to the Installation section for safety precautions and tools required.

7.1.1 Calculating Output Wire Size Requirements

Although DC power wiring and cabling in telecommunication applications tend to exceed electrical code requirements, mostly due to the voltage drop requirements, all applicable electrical code(s) take precedence over the guidelines and procedures in the present chapter, wherever applicable.

Wire size is calculated by first determining the appropriate maximum voltage drop requirement. Use the formula below to calculate the circular mil area (CMA) wire size requirement. Determine the size and number of conductors required to satisfy the CMA requirement.

$$\text{CMA} = (A \times \text{LF} \times K) / \text{AVD}$$

A = Ultimate drain in amps.

LF = Conductor loop feet.

K = 11.1 constant factor for commercial (TW type) copper wire.

AVD = Allowable voltage drop.

Check again that the ampacity rating of the cable meets the requirement for the installation application. Consult local electrical codes (NEC, CEC, etc.) for guidelines. If required, increase the size of the cable to meet the code.

Refer to Table B for cable size equivalents.

Table B — Cable size equivalents (AWG to Metric)

Cable size	Circular mils	Square millimeters	Equivalent metric cable
20 AWG	1020	0.519	1
18 AWG	1624	0.8232	1
16 AWG	2583	1.309	1.5
14 AWG	4107	2.081	2.5
12 AWG	6530	3.309	4
10 AWG	10380	5.261	6
8 AWG	16510	8.368	10
6 AWG	26250	13.30	16
4 AWG	41740	21.15	25
2 AWG	66370	33.63	35
0 AWG (or 1/0)	105600	53.48	50 or 70
00 AWG (or 2/0)	133100	67.42	70
0000 AWG (or 4/0)	211600	107.2	120

Cable size	Circular mils	Square millimeters	Equivalent metric cable
313 MCM (or kcmil)	313600	159	150 or 185
350 MCM (or kcmil)	350000	177.36	185
373 MCM (or kcmil)	373700	189	185 or 240
500 MCM (or kcmil)	500000	253.36	300
535 MCM (or kcmil)	535300	271	300
750 MCM (or kcmil)	750000	380.00	400
777 MCM (or kcmil)	777700	394	400

7.1.2 Recommended Torque Values

Table C lists the recommended torque values for connection to the power system with the following hardware:

- Clear hole connections (nut and bolt)
- PEM studs
- PEM threaded inserts
- Thread formed connections (in copper bus bar)

1/4"	8.8 ft-lbs
3/8"	32.5 ft-lbs
1/2"	73 ft-lbs

Grade 5 rated hardware is required for these torque values.

7.2 Grounding

This power system is suitable for installation as part of a Common Bonding Network (CBN) and is intended to be used in a DC-C configuration (common DC return).

Connect the isolated power system battery return bus (BRB) to the building master ground bus (MGB), or floor ground bus (FGB) in a larger building. This acts as a system reference and as a low impedance path to the ground for surges, transients, noise, etc. The MGB or FGB must have a direct low impedance path to the building grounding system.

The cable from the power system to the MGB or FGB must be sized to provide sufficient ampacity to clear the largest fuse or breaker on the power system, excluding the battery protection fuse or circuit breaker. 750 MCM is recommended. This is the minimum requirement. Other factors including the length of the cable and special grounding requirements of the load must also be factored in. The insulated cable must be equipped with two-hole crimp type lugs and must not have any tight bends or kinks.

Power system ampacity	Ground reference conductor size
< 30A	#10
30 – 100A	#6 to #2
100 – 400A	0000
400 – 800A	350 MCM
> 800A	750 MCM

The power system frame must also be connected to the MGB or FGB for personnel safety and to meet many telecom grounding requirements. Each rack must have its own frame or site ground connection.

7.3 CAN Serial Ports (Rectifier Shelf)

Two CAN Serial ports (modular jacks), are provided for communications with Alpha Cordex controllers and other CAN-enabled equipment. These are located on the left side of the rectifier shelf as viewed from the front.

1. Daisy-chain from shelf to shelf (CAN 1 of one shelf to CAN 2 of another) as shown in Figure 9.
2. Insert a CAN terminator (part number 5450228-001) in the last CAN bus position at the end of the daisy chain.

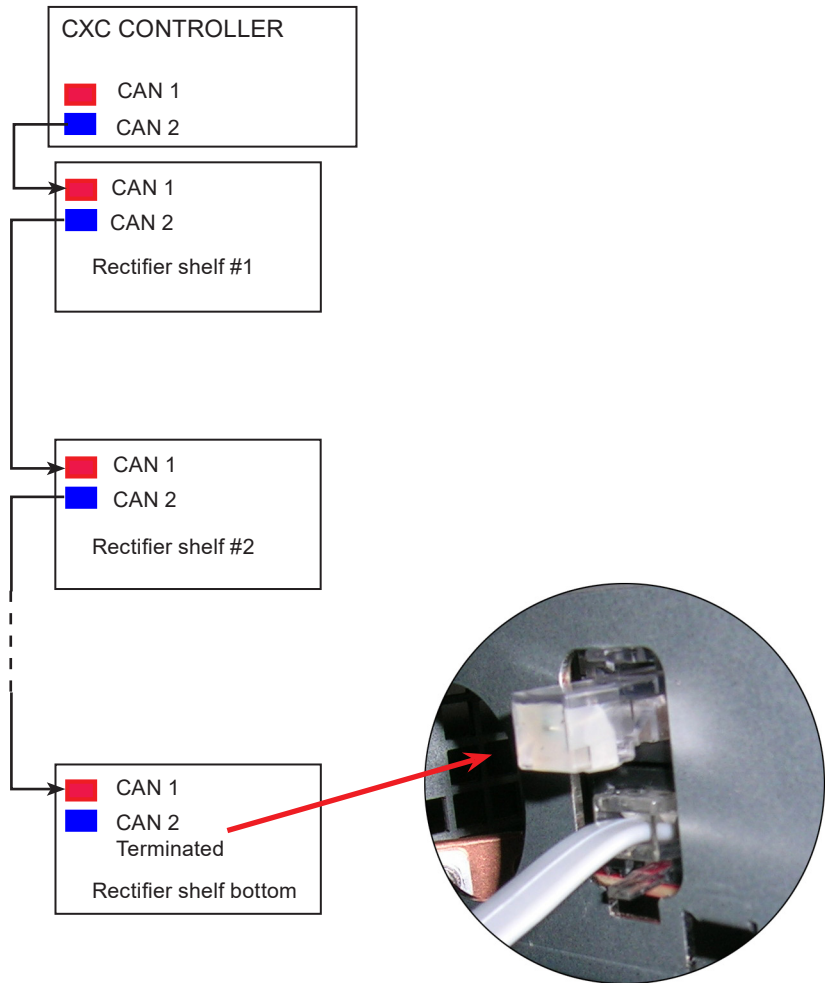

Figure 9 — CAN Bus Cabling

7.4 AC Wiring 23" Shelf

7.4.1 AC Feeder Protection/Sizing

To maximize system reliability, each feed should have a dedicated protection feeder breaker located at the AC distribution panel. The feeder breaker can also act as the disconnect device for the connected modules. Refer to section "3.3.1 Cordex 48-3.0kW Rectifier Shelves" on page 10 for breaker and wire size recommendations.

7.4.2 AC Input Connections



CAUTION!

To minimize EMI disturbances, route the AC input wires in flexible or rigid conduit and located as far away as possible from the DC power wires.



WARNING!

Use care when removing or replacing the covers for the AC input connections. Never assume that an electrical connection or conductor is not energized.

1. Ensure that all modules are removed from the shelf.
2. At the rear of the shelf, remove screw and flip the cover down (two places) to access the AC input terminal blocks: each terminal pair corresponds to either two rectifiers or a single rectifier as shown in Figure 10.
3. The wire way is designed for two customer-supplied, 3/4" trade size conduit fittings for the AC supplies located on each side of the shelf. Attach the conduit retainers to the wire way hole(s) and route the AC cables through them.
4. Secure the wires to the AC input and AC ground terminals (15 in. lbf) and AC ground terminal (35 in. lbf). Refer to Figure 10 and customer connection drawing 0300057-08 at the end of the manual.
5. Tighten the cable connector to the AC cable (conduit similar).
6. Replace rear cover(s) once all connections have been completed.

NOTE: Rectifier slot numbers 1 to 5 from the left front of the shelf (for reference only).

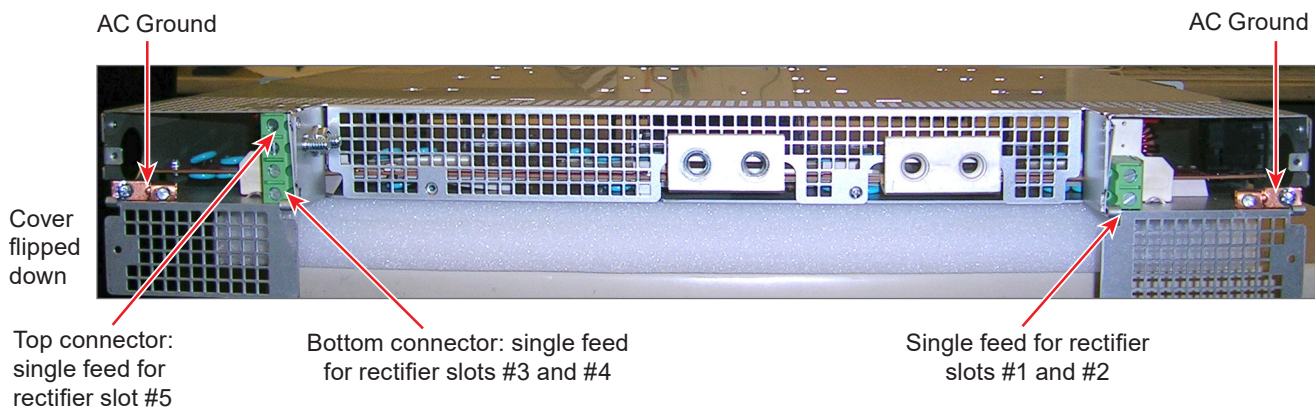

Figure 10 — AC Input and Ground for 23" Shelf

7.5 AC Wiring 19" Shelf

For the 19" shelf, AC wiring is fed separately to each of the four rectifiers.

7.5.1 AC Feeder Protection/Sizing

To maximize system reliability it is recommended that, each power module be fed from a dedicated protection feeder breaker located at the AC distribution panel. The feeder breaker can also act as the disconnect device for the connected module. Refer to section "3.3.1 Cordex 48-2.4kW Rectifier Shelves" on page 10 for breaker and wire size recommendations.

7.5.2 AC Input Connections



CAUTION!

To minimize EMI disturbances, route the AC input wires in flexible or rigid conduit and located as far away as possible from the DC power wires.



WARNING!

Use care when removing or replacing the covers for the AC input connections. Never assume that an electrical connection or conductor is not energized.

1. Ensure that all rectifier modules are removed from the shelf.
2. At the rear of the shelf, remove the screw and flip the cover down (two places) to access the AC input terminal blocks. Each terminal pair corresponds to an individual rectifier as marked.
3. The wire way is designed for two customer-supplied, 3/4" trade size conduit fittings on each side of the shelf. Attach the conduit retainers to the wire way hole(s) and route the AC cables through them.
4. Secure the wires to the AC input connections (torque spec. 15 in. lbf) and AC ground terminal (35 in. lbf) as shown in drawing #0300040-08 at the end of this manual.
5. Tighten the cable connector to the AC cable (conduit similar).
6. Replace rear cover(s) once all connections have been completed.

7.6 DC Output Connections - Bulk Distribution

WARNING!

Do not complete the final live connections to the battery. Leave open and insulate the final connections or remove the battery fuses. Switch off the battery contacts if used.

The DC output wires must be UL approved XHHW or RHH/RHW (RW90 type for Canadian users). Control and sense wires must be UL approved Style 1015 (TEW type for Canadian users).

The common output leg of the rectifier system must be connected to the ground. This is typically done at the load common termination point.

The 23" and 19" bulk distribution models have positive and negative output bars.

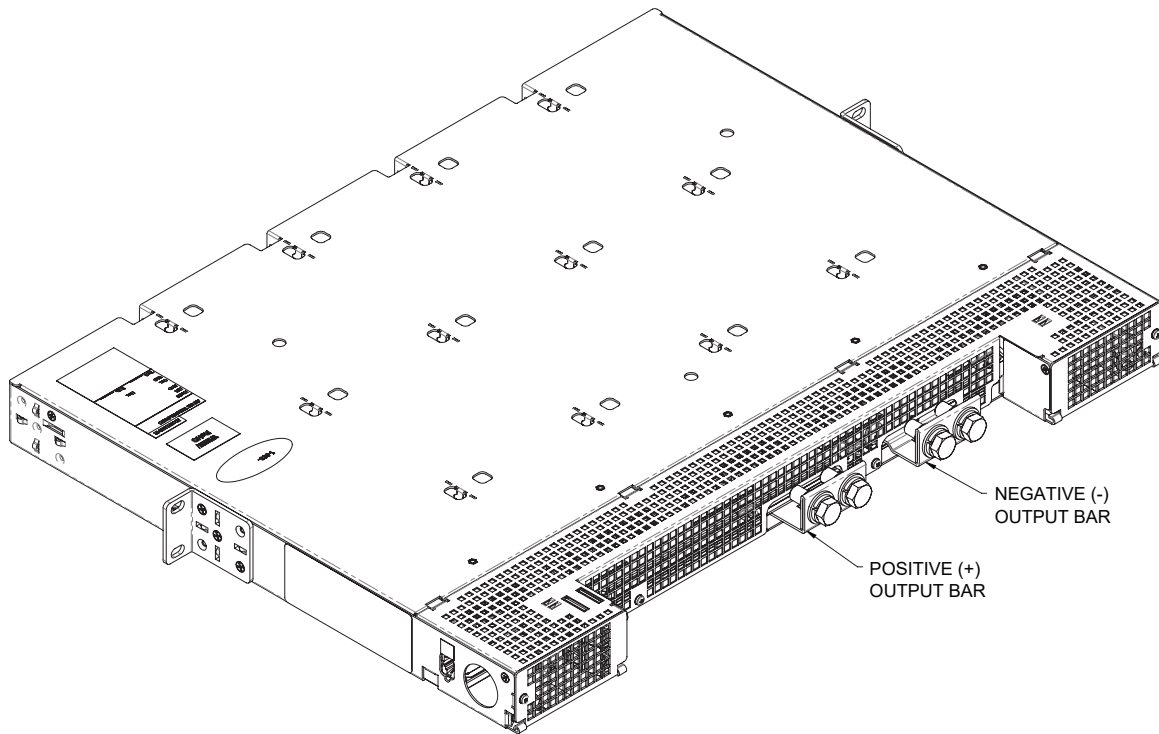

Figure 11 — Positive and Negative Output Bars on 23" and 19" Bulk Distribution Models

7.6.1 Busbar Connection

Multiple shelves can be connected directly to customers' vertical busbar.

1. Remove the bolts and washers at both positive and negative output bars. Bolts are 3/8-16 x 1", and can accommodate up to 1/4" thick busbar.
2. Use fasteners removed from the previous step to secure the vertical busbars to shelf positive and negative output bars. Install all fasteners "FINGER TIGHT", then apply 20 ft-lbf torque to each bolt.
3. Refer to the system startup procedure before connecting batteries online.

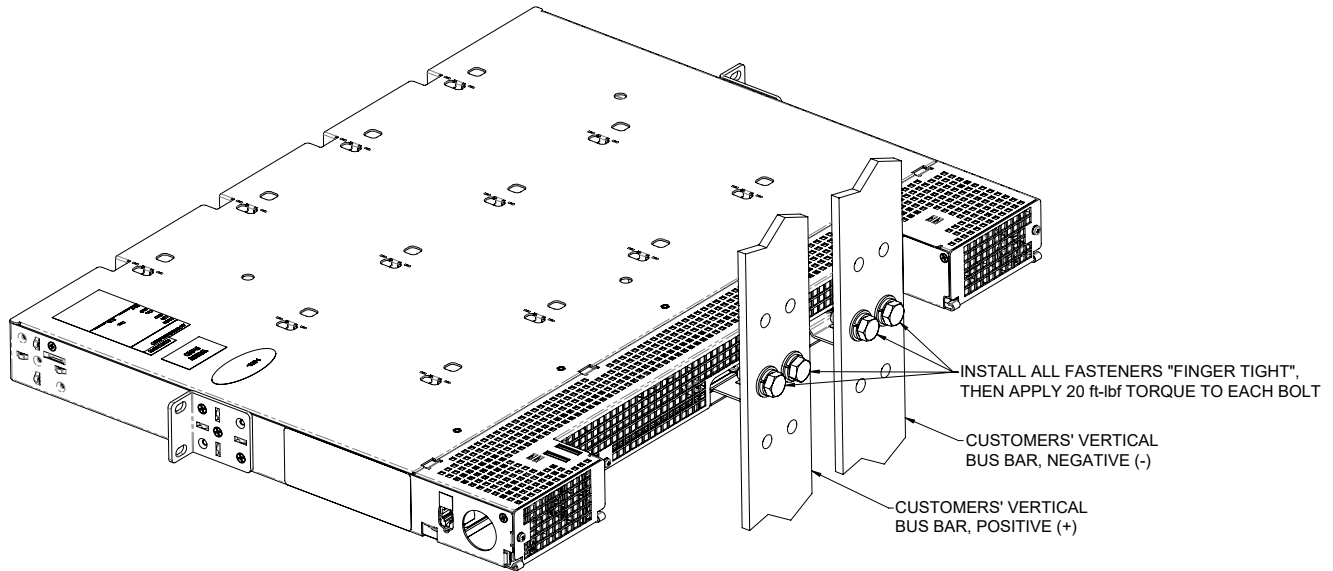

Figure 12 — Connecting Output Bars to Customer's Vertical Busbars

7.6.2 Cable Connection

When attaching cables directly to the output bars, use appropriately sized cables terminated with crimp lugs with 3/8" holes on 1" centers.

1. Remove the bolts and washers at both positive and negative output bars. Bolts are 3/8-16 x 1"
2. Use fasteners removed from the previous step to secure the positive and negative cables to the shelf output bars. Install all fasteners "FINGER TIGHT".
3. Use a "Tongue and Groove" or similar plier to hold and stabilize the output bar, torque each bolt to 20 ft-lbf.

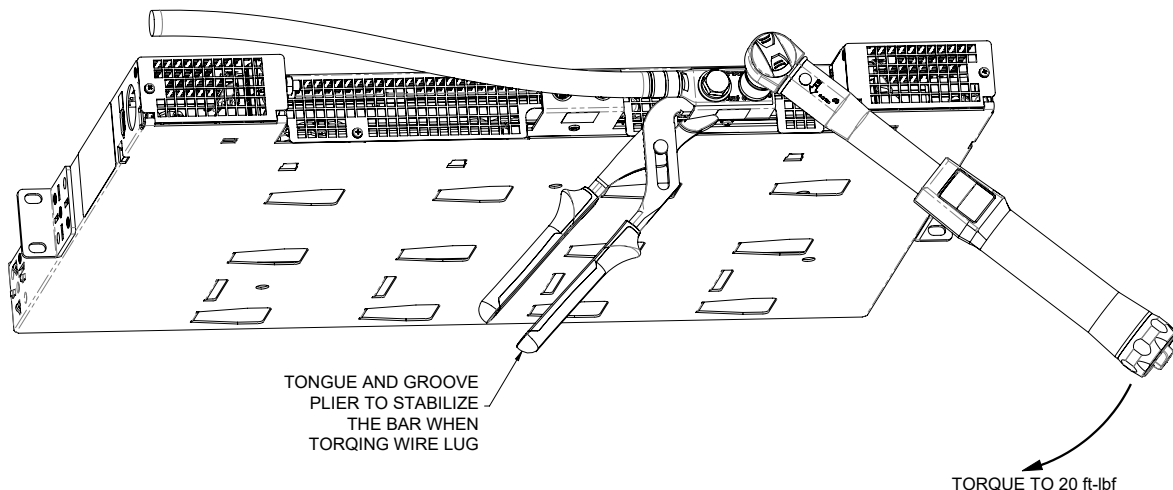

Figure 13 — Connecting Output Bars Directly to Cables

7.7 DC Output Connections - Single Component Distribution

WARNING!

Do not complete the final live connections to the battery. Leave open and insulate the final connections or remove the battery fuses. Switch off the battery contacts if used.

The DC output wires must be UL approved XHHW or RHH/RHW (RW90 type for Canadian users). Control and sense wires must be UL approved Style 1015 (TEW type for Canadian users).

- Use appropriately sized cables terminated with crimp lugs for M6 screws on 5/8" centers. Torque to 8 ft-lbf.

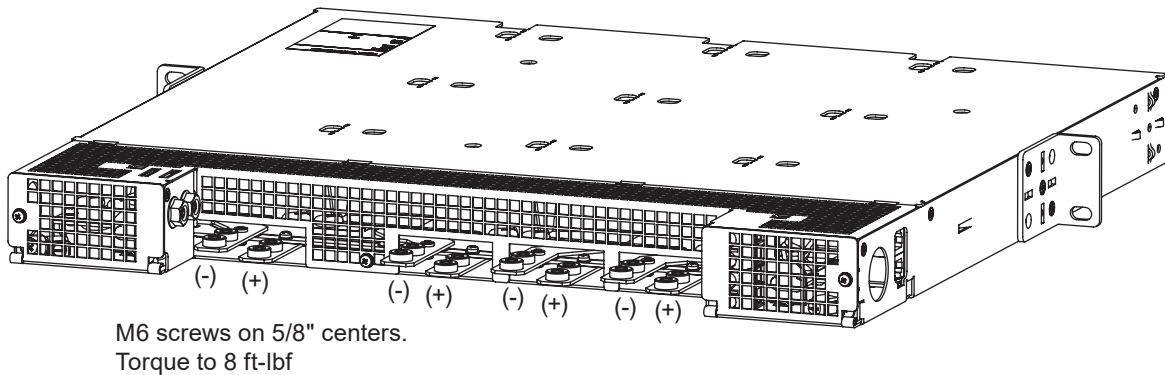

Figure 14 — 19" Shelf in with Single Component Distribution

8. System Startup

Visually inspect the installation thoroughly.

After completing the system installation and power system wiring, perform the following startup and test procedure to ensure proper operation:

8.1 Check System Connections

1. Make sure that the AC input power is switched off, the batteries are disconnected, and all the power modules are removed from the shelf.
2. Triple-check the polarity of all connections.

8.2 Verify AC and Power the Rectifier Shelf

NOTE:

Do not force a module into position if it does not seat properly. All modules are keyed to ensure that the correct module (voltage/polarity) type is used.

1. Install one power module into the left most position using the side of the shelf as a guide.
 - a. Place the rectifier module on the shelf bottom and slide the module into the rear connector (inside the shelf).
 - b. Apply pressure on the module handle to engage the rear connector in the shelf receptacle.
 - c. Place the handle in the down position to secure the module to the shelf.
2. Verify that the AC input voltage is correct and switch on the corresponding feeder breaker. The power module **AC ON** LED illuminates after a preset start delay. (See the Product Features 4 on page 11 for a description of the LEDs.)
3. Use the CXC, if installed, to test the functionality of various module alarms and controls.

8.3 Check Battery Polarity and Connections

1. Use a voltmeter to verify that the battery polarity is correct. Ensure that no cells or batteries are reversed.
2. Connect the batteries to the output of the system.
3. Install the remaining power modules.
4. In the adjustments menu of the CXC, set the float and equalize voltages to the levels specified by the battery manufacturer.
5. Using the CXC, test the functionality of the various module alarms and controls. Perform a load test with the system using a resistive load box.
6. Enable the temperature compensation (temp comp) feature in the batteries menu. Program the settings for slope and breakpoints (upper and lower) according to the specific batteries used.

9. Rectifier Modes and Factory Defaults

9.1 Rectifier Modes

There are two main rectifier modes: output voltage mode and the output current/power mode.

9.1.1 Output Voltage Modes

Voltage modes are under software control, and can be used to directly adjust the output voltage. The qualification of “under software control” is made because there are processes that occur in the rectifier that can change the output voltage that do not adjust the output voltage directly, for example, if the rectifier has reached the current limit.

Table E lists four output voltage modes and a description of when they are active. These modes can be set via the controller.

Output Voltage Modes	Active when...
Float	Output voltage is set to the float voltage setting.
Equalize	Output voltage is set to the equalize voltage setting.
Battery Test	Output voltage is set to the battery test voltage setting.
Safe	If the rectifier is not connected to a controller, the rectifiers will switch to safe mode (51.4V) after 5 minutes

9.1.2 Output Current/Power Modes

These modes directly affect the output current and power. Table F lists the four output current/power modes and a description of when they are active.

Output Voltage Modes	Active when...
Temperature foldback mode	Output current and power limit have been reduced because a high temperature has been detected on the heatsink or internal ambient temperature sensor.
AC foldback mode	Output current and power limits have been reduced because the AC input voltage is low. This will reduce the risk of tripping an AC breaker due to increased AC current draw as the AC voltage decreases.
Short circuit foldback mode	Output current limit has been reduced due to a short circuit at the output.
Internal fault foldback mode	Output current limit has been reduced due to an internal fault.
Constant power mode	If the output current exceeds max rated current, the rectifier puts out constant power within a specific voltage range. The rectifier is in constant power mode.
Overload	If the load current increases further, the output voltage and current will reduce. This mode is called fold back mode or Over Load.

9.2 Factory Ranges and Defaults

Table G shows the rectifier settings/ranges/defaults. Changes are made through the CXC interface.

Table G — Rectifier factory ranges and defaults		
Setting	Range (minimum to maximum)	Default
Float (FL) Voltage	47.5 – 58.2V	54V
Equalize (EQ) Voltage	49.8 – 60.2V	55V
Battery Test (BT) Voltage	44 – 52V	46V
Over Voltage Protection (OVP)*	63V	63V
Current Limit (CL)	20 – 100%	100%
Power Limit (PL)	0 – 100%	100%
Module Start Delay	0 – 250s	1s
System Start Delay	0 – 600s	0s
Low Voltage Alarm (LVA)	42 – 52V	44V
High Voltage Alarm (HVA)	52 – 63V	55.5V
EQ Timeout	1 – 2399h	30 h
BT Timeout	1 – 250h	8 h
Softstart Ramp-rate	Normal/Fast	Normal
CL/PL Alarm	Enable/Disable	Enable
Remote Shutdown	Enable/Disable	Enable
Ramp Test	Enable/Disable	Enable

*The OVP cannot be set below the present system/FL/EQ/BT voltage setting or the safe mode voltage of 51.4 V.

10. Maintenance

Although very little maintenance is required with Alpha systems, routine checks and adjustments are recommended to ensure optimum system performance. Qualified service personnel should do the repairs.

The following table lists a few maintenance procedures for this system. These procedures should be performed at least once a year.



WARNING!

Use extreme care when working inside the unit while the system is energized. Do not make contact with live components or parts.



Circuit cards, including RAM chips, can be damaged by static electricity. Always wear a grounded wrist strap when handling or installing circuit cards.

Ensure redundant modules or batteries are used to eliminate the threat of service interruptions while performing maintenance on the system's alarms and control settings.

Table H — Sample maintenance log

Procedure	Date Completed
Clean ventilation openings.	
Inspect all system connections. Re-torque if necessary.	
Verify alarm/control settings.	
Verify alarm relay operation.	

10.1 Replacing a Rectifier Module via the CXC HP Controller

When a rectifier is permanently removed, the system generates a **Rectifier Comms Lost** alarm. That alarm is cleared by removing the rectifier from the system inventory.

To remove the rectifier from the system inventory do the following:

1. Remove the defective rectifier from the shelf.
2. To remove a module, flip the handle up and pull the module away from the rear connector and out of the shelf.

- In the web user interface go to **Power System > Inventory > Rectifiers > Status**.

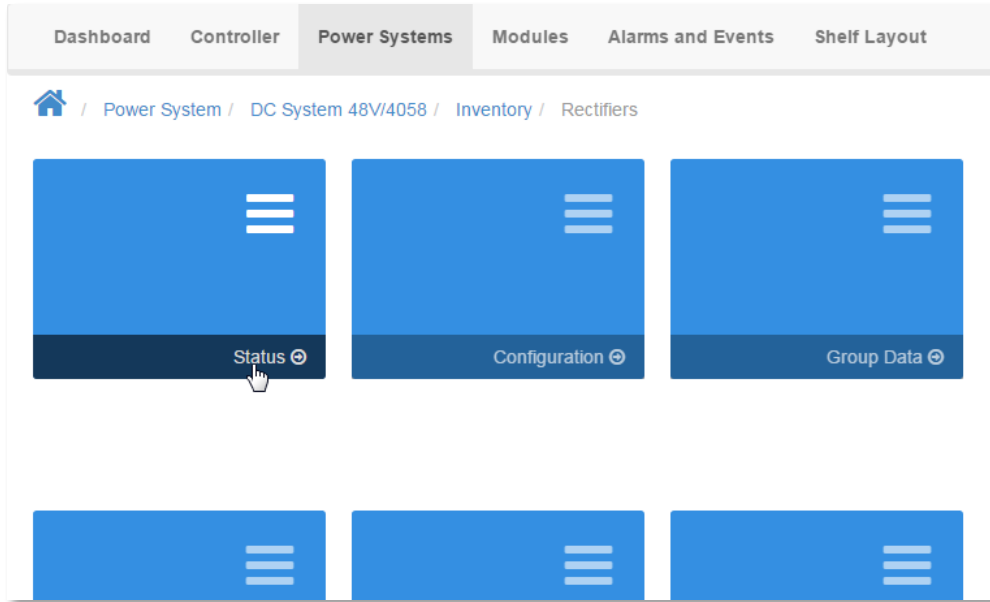

- Click the **Unassign** button on the rectifier to be removed and confirm.
- Place the new rectifier in the shelf.
- Rectifiers are plug-and-play, but you may still need to map the new rectifier to an AC phase.
- If not set to auto-assign, go to **Modules > Unassigned Modules** to assign new rectifier.
- Confirm the assignment.

10.2 Replacing a Rectifier Module via CXC Controller

The rectifier is plug and play. When a rectifier module is added to the system, the CXC will detect and update the inventory automatically. Replacing an installed rectifier requires a manual Inventory Update at the controller to clear the removed rectifier from its current list of rectifiers.

- To remove a module, flip the handle up and pull the module away from the rear connector and out of the shelf.
- At the controller LCD initiate an Inventory Update as follows (or **Main Menu > Rectifiers > Inventory Update** for the web interface):

Tap the Rectifier icon on the controller home page.

Tap Inventory Update.

A pop-up window appears with a progress bar showing the number of modules acquired during the update.

Inventory Update clears the current list of rectifiers and re-acquires all connected modules.

- Place the new rectifier module on the shelf bottom. Lift the handle and slide the module into the rear connector (inside the shelf). Apply pressure to the module front panel to engage the rear connector in the shelf receptacle.
- Flip the handle down to lock the module in place.

10.3 Fan Replacement

The fan assembly part number is 7400732-001. The Fan on the individual rectifiers is designed for very high reliability and long life. During year 6 of the life of the product the manufacturer recommends replacement of the fan assembly.

1. Lift the locking handle and slide the module 10 cm (4") out of the shelf. Wait ten minutes for the module capacitors to discharge and then slide the rectifier out of the shelf.
2. Remove the two bottom screws that secure the front panel to the module chassis (Figure 15).

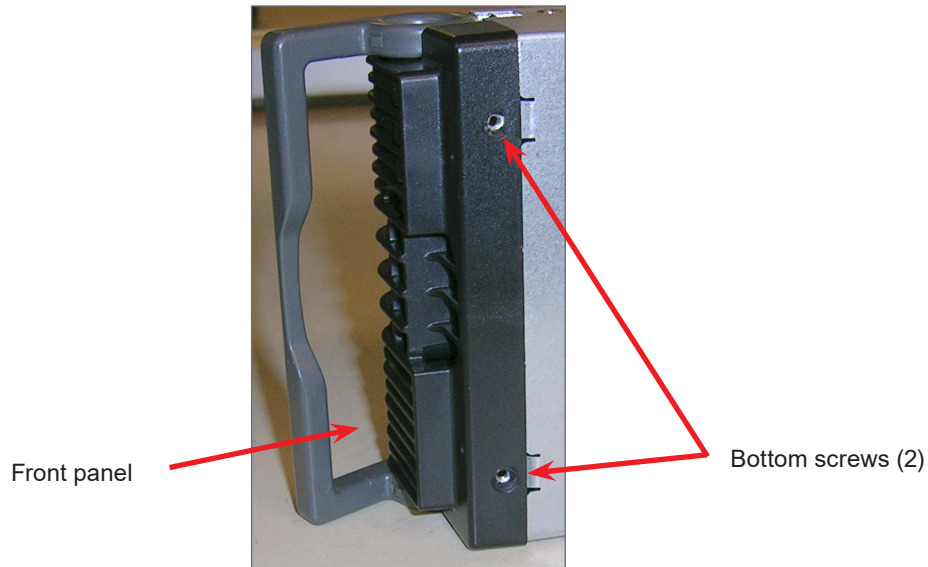

Figure 15 — Rectifier Bottom View

3. Push in the two plastic protrusions (Figure 16) on top of the rectifier and disengage the front panel and attached fan from the rectifier.



Figure 16 — Removing Front Panel from Rectifier

4. Disconnect the fan cables from the module by pulling out the fan cable connector.
5. Discard the old fan assembly and unpack the new replacement assembly.

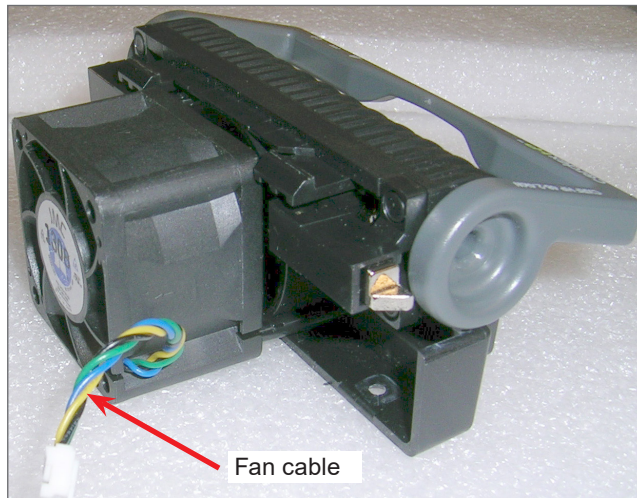

Figure 18 — 2.4kW Rectifier Fan Assembly

6. Reconnect the fan cable. Insert the connector into the fan connector in the module. Ensure proper polarity and that the wires stay clear of the fan blade.
7. Slide the front panel into the rectifier body.

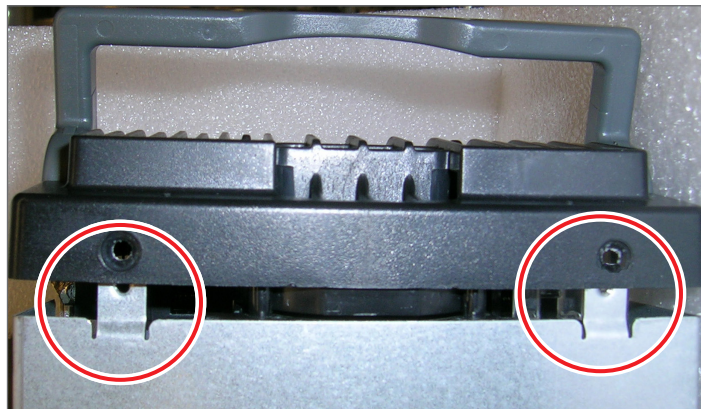

Figure 17 — Reattaching the Front Panel

8. Ensure the metal tabs of the rectifier body aligned with the screw holes of the front panel.
9. Ensure the plastic tabs of the front panel are protruding through the metal cutouts in the rectifier body.



Figure 19 — Locking the Front Panel in Place

10. Secure the front cover by hand tightening the bottom screws, see Figure 15.

11. Troubleshooting

The rectifiers and the shelves are designed for simple installation and reliable, trouble-free operation for several years.

In most cases the rectifiers will recover from minor alarms and faults automatically. However under certain conditions the rectifiers may need remote control. And under very rare cases the rectifier may need a manual reset (unplug and reinsert the rectifier). In the unlikely event of a rectifier failure, it may need replacement.

A 2.4KW rectifier shelf can have 4 or 5 rectifiers in it, depending on the model. The rectifiers have 3 LED indicators that provide information about the system. Refer to the LED section, 4.1.1 on page 11 for details.

When the 2.4KW shelf system is used in conjunction with a controller, detailed system informations and status can be obtained through it. Even more information can be obtained using the web interface using the Ethernet port.

Table below provides a quick look up at the LEDs and the corresponding rectifier states.

AC	DC	Alarm/Fault	Rectifier State	Possible Causes	Solutions
green	green	off	Normal operation		
green	off	off	Unit has no DC output	Unit is in Power Save mode	Unit will automatically resume power delivery power when load is increased or when the Remote restart is enabled.
off	off	off	Unit may not be plugged in or system is off or unit has failed		Plug in unit completely, check AC and DC wiring
off	off	red	Unit has shut down due to a fault and may need to be reset. Check controller or web interface to find the fault details	AC not qualified unit has failed	
green	off	red	Unit has shut down due to a fault and may need to be reset. Check controller or web interface to find the fault details	Depending on the fault the unit may or may not recover automatically	Over temperature fault, will auto recover, plug unit into the shelf
green	off	blinking red	Unit has an alarm		Check the controller front panel or web interface to find out the details of the alarm
green	green	blinking red	Unit has an alarm.		Check the controller front panel or web interface to find out the details of the alarm
green	green	red	Normal Operation	Unit is on No LOAD, and no battery is connected. CXC will report ramp test fail.	Add load or connect battery, or disable ramp test

12. Acronyms and Definitions

AC	Alternating current
ANSI	American National Standards Institute
AWG	American Wire Gauge
BTU	British thermal unit
CAN	Controller area network
CEC	Canadian Electrical Code
CSA	Canadian Standards Association
CX	Cordex™ series; e.g., CXC for Cordex System Controller
DC	Direct current
EIA	Electronic Industries Alliance
EMC	Electromagnetic compatibility
EMI	Electromagnetic interference
ERM	Electromagnetic Compatibility and Radio Spectrum Matters
ESD	Electrostatic Discharge
FCC	Federal Communications Commission (for the USA)
HVSD	High voltage shutdown
IEC	International Electrotechnical Commission
IEEE	Institute of Electrical and Electronics Engineers
IP	Internet Protocol
LED	Light emitting diode
LVD	Low voltage disconnect
MIL	One thousandth of an inch; used in expressing wire cross sectional area
MOV	Metal oxide varistor
MTBF	Mean time between failures
NC	Normally closed
NEC	National Electrical Code (for the USA)
NO	Normally open
OSHA	Occupational Safety & Health Administration
OVP	Over voltage protection
RAM	Random access memory
RU	Rack unit (1.75")
TCP/IP	Transmission Control Protocol / Internet Protocol
THD	Total harmonic distortion
UL	Underwriters Laboratories
VRLA	Valve regulated lead acid

13. Warranty Statement and Service Information

13.1 Technical Support

In Canada and the USA, call toll free 1-888-462-7487.

Customers outside Canada and the USA, call +1-604-436-5547.

13.2 Warranty Statement

For full information details review Alpha's online Warranty Statement at www.alpha.ca/support.

13.3 Product Warranty

Alpha warrants that for a period of two (2) years from the date of shipment its products shall be free from defects under normal authorized use consistent with the product specifications and Alpha's instructions, the terms of the manual will take precedence.

The warranty provides for repairing, replacing or issuing credit (at Alpha's discretion) for any equipment manufactured by it and returned by the customer to the factory or other authorized location during the warranty period.

There are limitations to this warranty coverage. The warranty does not provide to the customer or other parties any remedies other than the above. It does not provide coverage for any loss of profits, loss of use, costs for removal or installation of defective equipment, damages or consequential damages based upon equipment failure during or after the warranty period. No other obligations are expressed or implied. Warranty also does not cover damage or equipment failure due to cause(s) external to the unit including, but not limited to, environmental conditions, water damage, power surges or any other external influence.

The customer is responsible for all shipping and handling charges. Where products are covered under warranty Alpha will pay the cost of shipping the repaired or replacement unit back to the customer.

13.4 Battery Warranty

Note that battery warranty terms and conditions vary by battery and by intended use. Contact your Alpha sales representative or the Technical Support team at the above number to understand your entitlements under Battery Warranty.

13.5 Warranty Claims

Any claim under this Limited Warranty must be made in writing to Alpha BEFORE sending material back. Alpha will provide Product return instructions upon approval of return request. A Service Repair Order (SRO) and / or Return Authorization (RA) number will be issued ensuring that your service needs are handled promptly and efficiently.

Claims must be made online at: www.alpha.ca.

13.6 Service Information

For a list of international service centers, refer to the Alpha website: www.alpha.ca.

14. Certification

About CSA and NRTL

CSA (Canadian Standards Association also known as CSA International) was established in 1919 as an independent testing laboratory in Canada. CSA received its recognition as an NRTL (Nationally Recognized Testing Laboratory) in 1992 from OSHA (Occupational Safety and Health Administration) in the United States of America (Docket No. NRTL-2-92). This was expanded and renewed in 1997, 1999, and 2001. The specific notifications were posted on OSHA’s official website as follows:

- Federal Register #: 59:40602 - 40609 [08/09/1994]
- Federal Register #: 64:60240 - 60241 [11/04/1999]
- Federal Register #: 66:35271 - 35278 [07/03/2001]

When these marks appear with the indicator “C and US” or “NRTL/C” it means that the product is certified for both the US and Canadian markets, to the applicable US and Canadian standards. (1)

Alpha rectifier and power system products, bearing the aforementioned CSA marks, are certified to CSA C22.2 No. 60950-01 and UL 60950-01. Alpha UPS products, bearing the aforementioned CSA marks, are certified to CSA C22.2 No. 107.3 and UL 1778.

As part of the reciprocal, US/Canada agreement regarding testing laboratories, the Standards Council of Canada (Canada’s national accreditation body) granted Underwriters Laboratories (UL) authority to certify products for sale in Canada. (2)

Only Underwriters Laboratories may grant a licence for the use of this mark, which indicates compliance with both Canadian and US requirements. (3)



NRTLs capabilities

NRTLs are third party organizations recognized by OSHA, US Department of Labor, under the NRTL program.

The testing and certifications are based on product safety standards developed by US based standards developing organizations and are often issued by the American National Standards Institute (ANSI). (4)

The NRTL determines that a product meets the requirements of an appropriate consensus-based product safety standard either by successfully testing the product itself, or by verifying that a contract laboratory has done so, and the NRTL certifies that the product meets the requirements of the product safety standard. (4)

Governance of NRTL

The NRTL Program is both national and international in scope with foreign labs permitted.

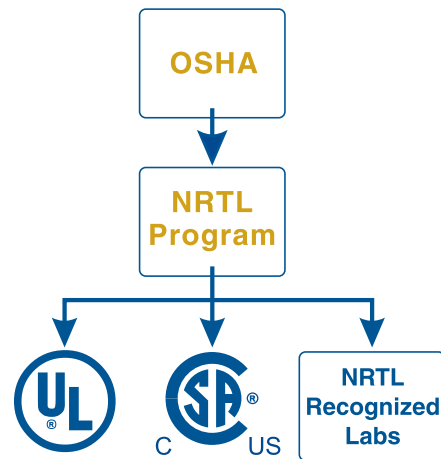

(1) www.csagroup.org

(2) www.scc.ca

(3) www.ulc.ca

(4) www.osha.gov

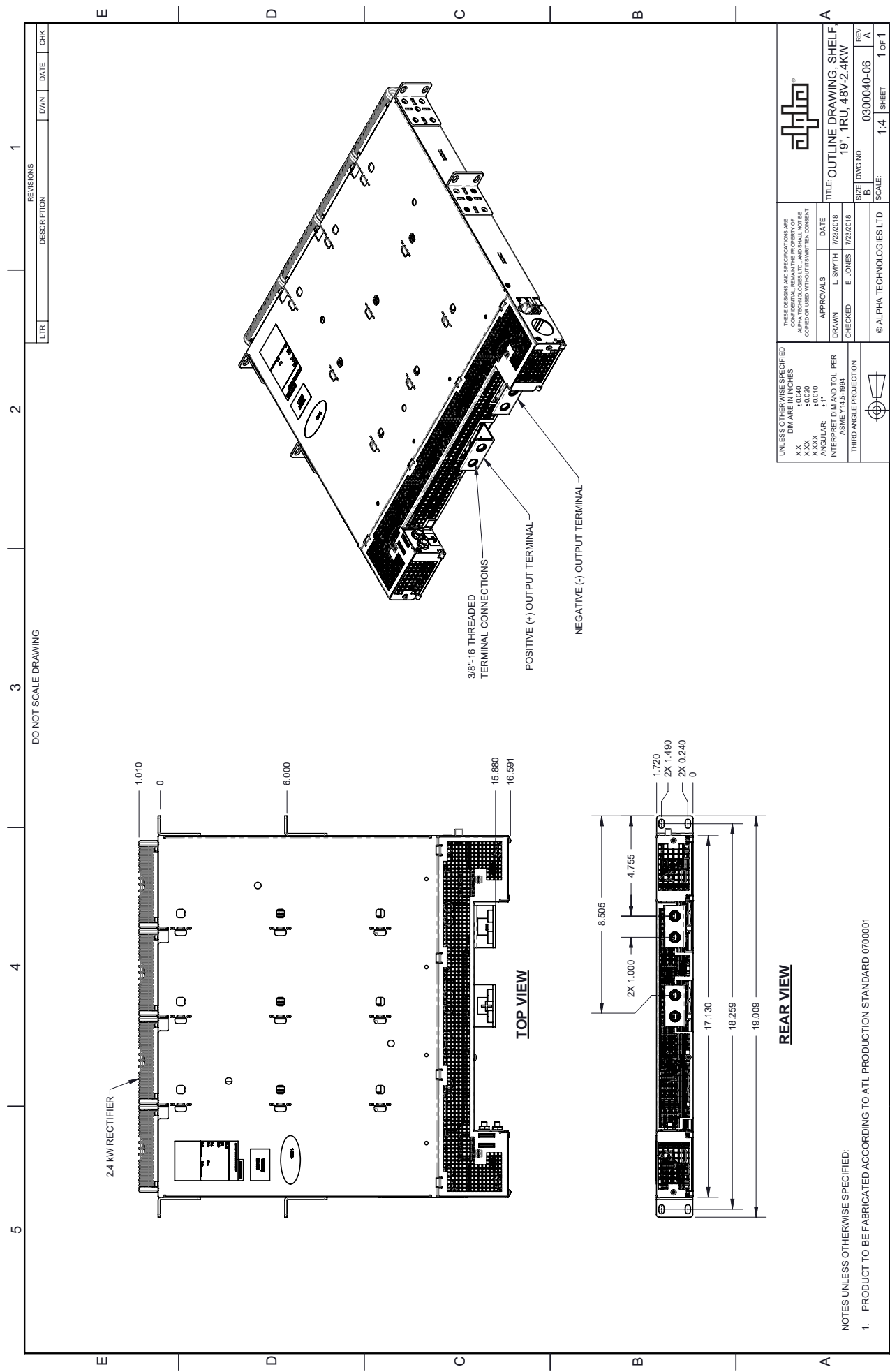

REVISIONS	
LTR	DESCRIPTION
DWN	DATE
CHK	

DO NOT SCALE DRAWING

UNLESS OTHERWISE SPECIFIED: DIM ARE IN INCHES XXX ±0.000 XXX ±.010 ANGULAR: 1°		THESE REVISIONS AND SPECIFICATIONS ARE THE PROPERTY OF ALPHA TECHNOLOGIES LTD. AND SHALL NOT BE COPIED OR USED WITHOUT ITS WRITTEN COMMENT	
INTERPRET DIM AND TOL PER ASME Y14.5-1994		THIRD ANGLE PROJECTION	
APPROVALS		DATE	
DRAWN	L. SMYTH	7/20/2018	
CHECKED	E. JONES	7/20/2018	

TITLE		OUTLINE DRAWING, SHELF	
SIZE		19" 1RU, 48V-2.4KW	
DWG NO.		0300040-06	
SCALE:		1:4	
SHEET		1 OF 1	

NOTES UNLESS OTHERWISE SPECIFIED:
1. PRODUCT TO BE FABRICATED ACCORDING TO ATL PRODUCTION STANDARD 0700001

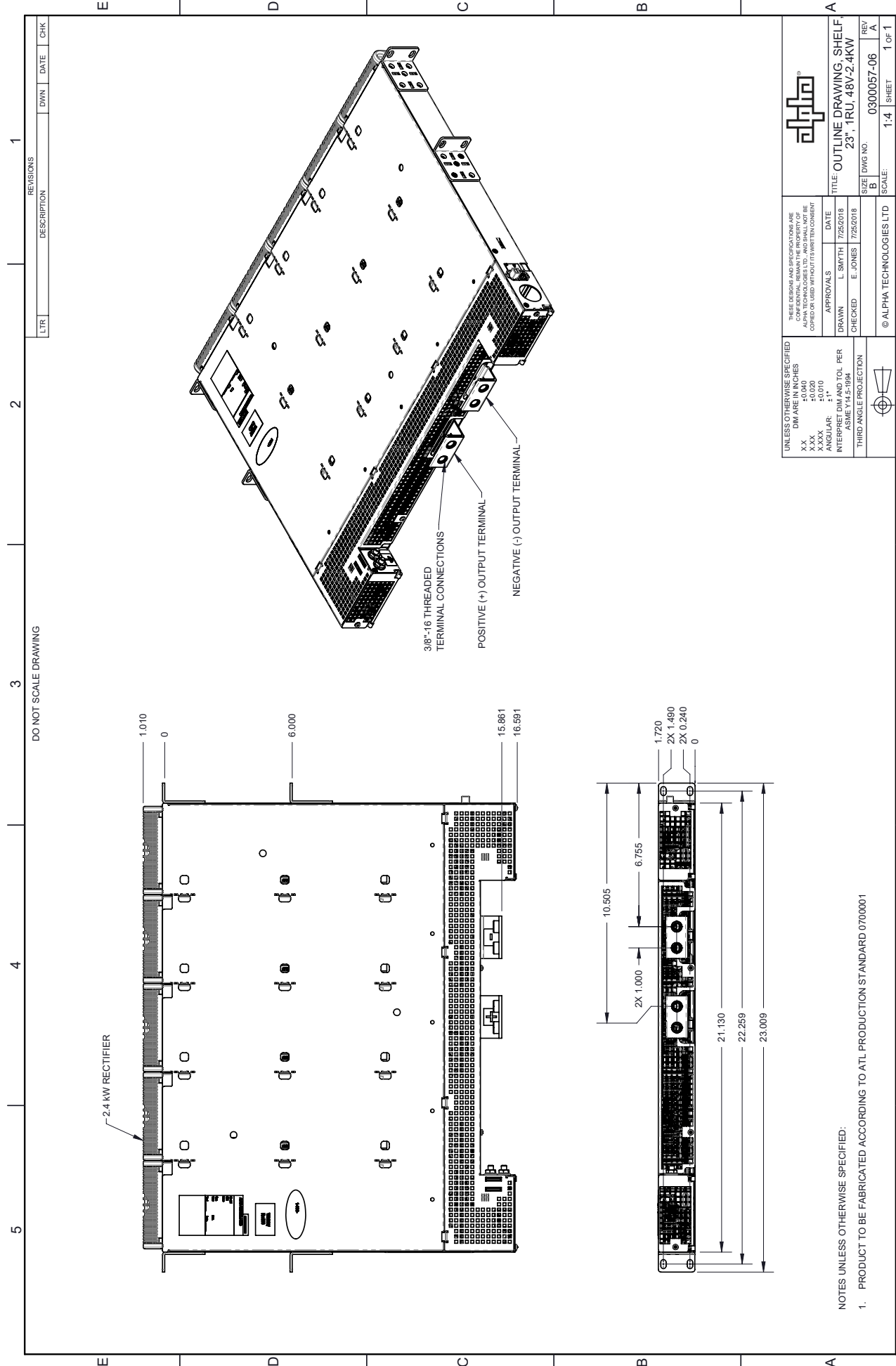

DO NOT SCALE DRAWING

REVISIONS		LTR	DESCRIPTION	DWN	DATE	CHK
1						

UNLESS OTHERWISE SPECIFIED DIM ARE IN INCHES XX ±0.040 XXX ±0.020 XXXX ±0.010 ANGULAR: 1° INTERPRET DIM AND TOL PER ASME Y14.5-1994 THIRD ANGLE PROJECTION		THESE REVISIONS AND SPECIFICATIONS ARE THE PROPERTY OF ALPHA TECHNOLOGIES LTD. AND SHALL NOT BE COPIED OR USED WITHOUT THEIR WRITTEN COMMENT	APPROVALS DRAWN L. SMYTH 7/26/2018 CHECKED E. JONES 7/26/2018	DATE 7/26/2018	TITLE OUTLINE DRAWING, SHELF 23", 1RU, 48V-2.4KW	SIZE B	DWG NO. 0300057-06	REV A
© ALPHA TECHNOLOGIES LTD				SCALE: 1:4	SHEET 1 OF 1			

NOTES UNLESS OTHERWISE SPECIFIED:
 1. PRODUCT TO BE FABRICATED ACCORDING TO ATL PRODUCTION STANDARD 0700001

DO NOT SCALE DRAWING

REVISIONS				
LTR	DESCRIPTION	DWN	DATE	CHK
B	DRAWING RECREATED (ORIGINAL MISSING)	WJD	Oct/19/15	JK

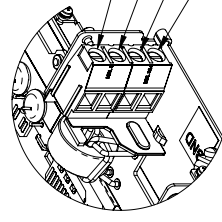
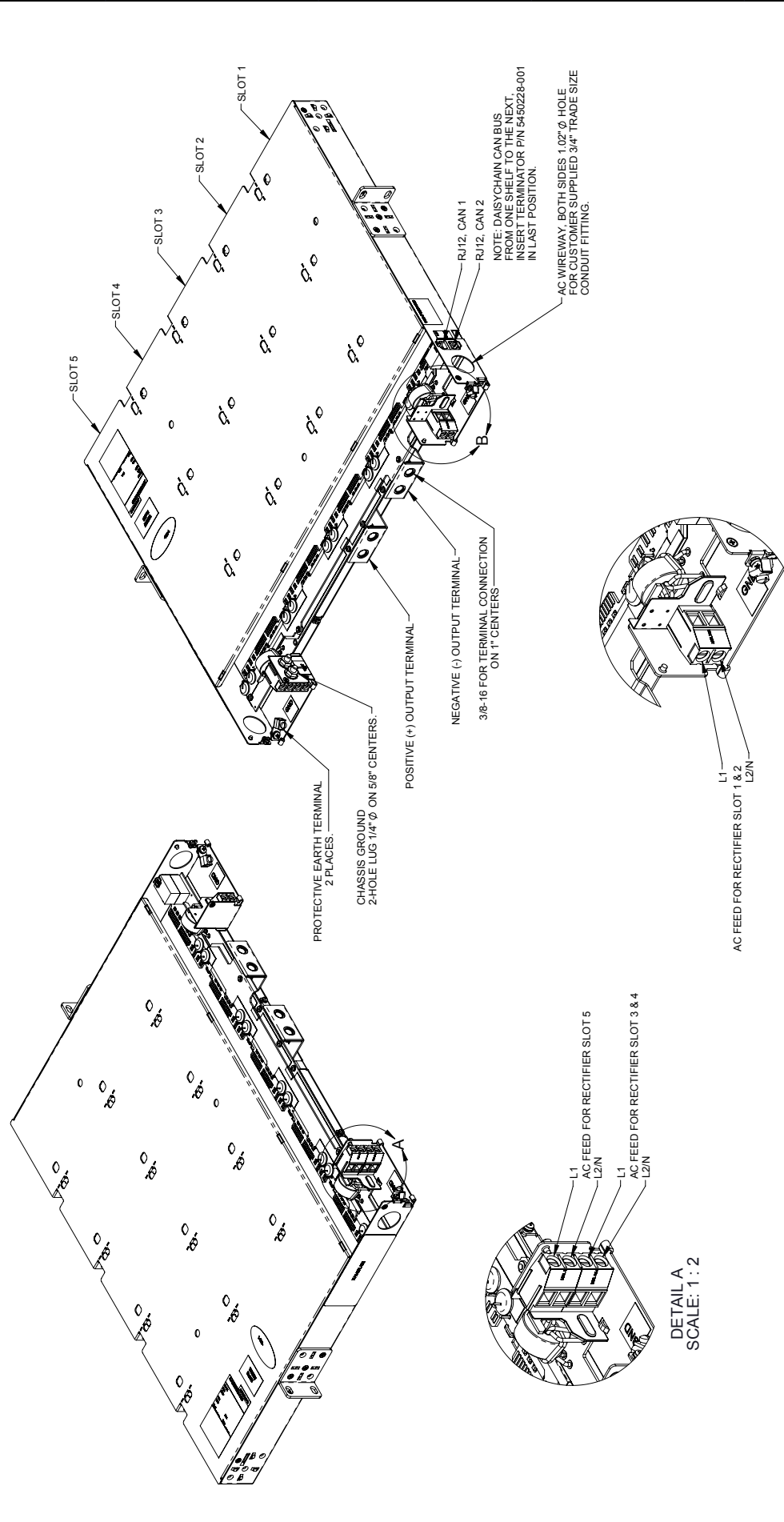

DETAIL A
SCALE: 1:2

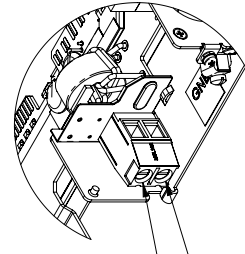

DETAIL B
SCALE: 1:2

NOTE: DAISYCHAIN CAN BUS FROM ONE SHELF TO THE NEXT, INSERT TERMINATOR PIN 5450228-001 IN LAST POSITION.

AC WIREWAY, BOTH SIDES 1.02" Ø HOLE FOR CUSTOMER SUPPLIED 3/4" TRADE SIZE CONDUIT FITTING.

UNLESS OTHERWISE SPECIFIED: DIM ARE IN INCHES X.X X.XX X.XXX ANGULAR: 1°/10' INTERPRET DIM AND TOL PER ASME Y14.5-1994 THIRD ANGLE PROJECTION		APPROVALS		DATE
DRAWN		WJD	19-OCT-15	
CHECKED		XX		

© ALPHA TECHNOLOGIES LTD		TITLE: CUSTOMER CONNECTION SHELF, 23" 1RU, 48V-2.4KW	
SIZE	DWG NO.	REV	REV
B	0300057-08	B	B
SCALE: 1:8		SHEET 1 OF 1	

NOTES UNLESS OTHERWISE SPECIFIED:
1. PRODUCT TO BE FABRICATED ACCORDING TO ATL PRODUCTION STANDARD 0700001

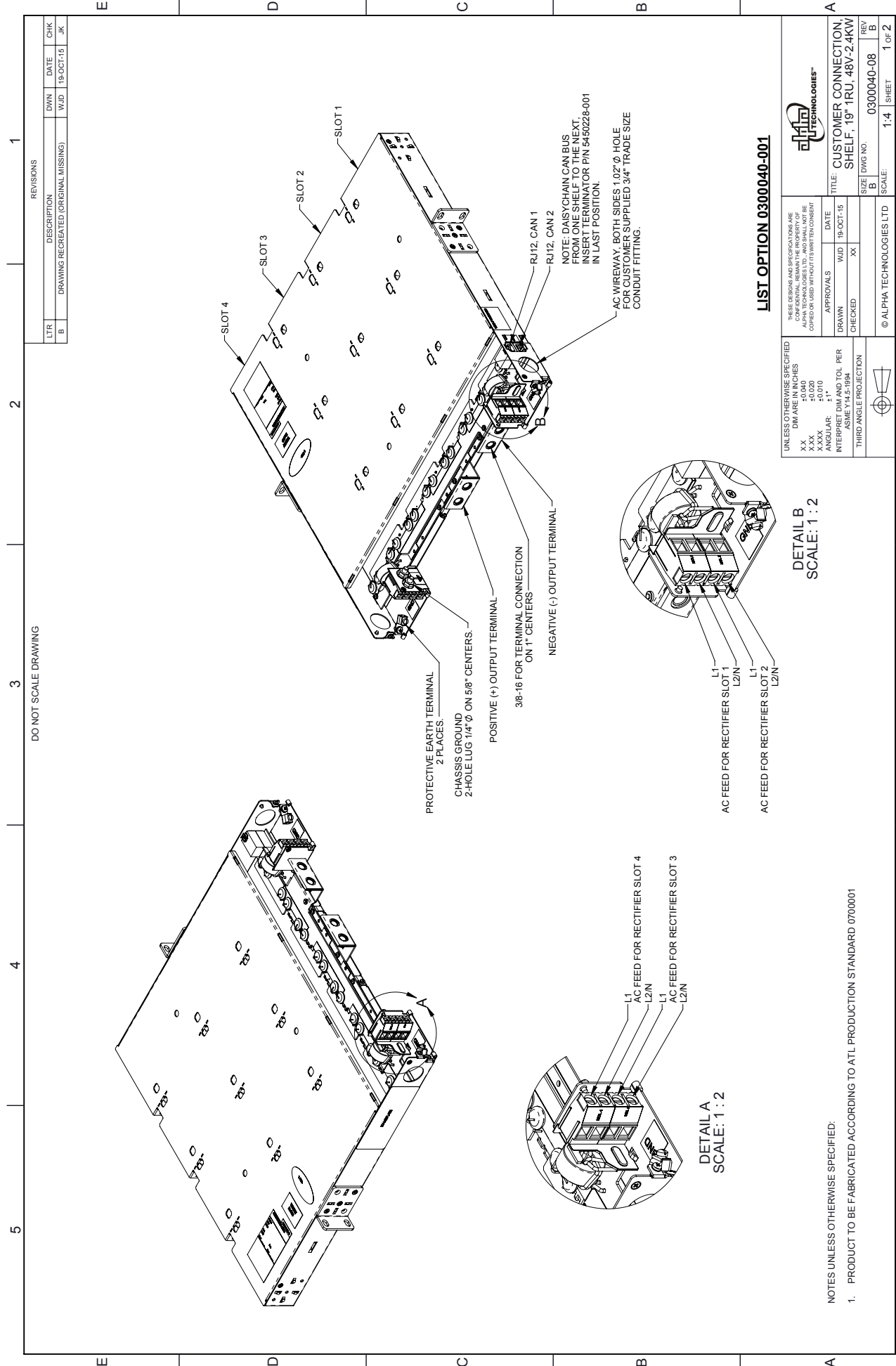

DO NOT SCALE DRAWING

REVISIONS			
LTR	DESCRIPTION	DWN	DATE
B	DRAWING RECREATED (ORIGINAL MISSING)	WJD	19-OCT-15
			CHK
			JK

LIST OPTION 0300040-001

UNLESS OTHERWISE SPECIFIED: DIM ARE IN INCHES XX ±0.040 XXX ±0.020 XXXX ±0.010 ANGULAR: ±1° INTERPRET DIM AND TOL PER ASME Y14.5-1994 THIRD ANGLE PROJECTION		APPROVALS		DATE
DRAWN		WJD	19-OCT-15	
CHECKED		XX		
TITLE: CUSTOMER CONNECTION SHELF, 19" 1RU, 48V-2.4KW		SIZE		REV
B		0300040-08		B
SCALE: 1:4		SHEET		1 OF 2

DETAIL B
SCALE: 1 : 2

DETAIL A
SCALE: 1 : 2

- NOTES UNLESS OTHERWISE SPECIFIED:
1. PRODUCT TO BE FABRICATED ACCORDING TO ATL PRODUCTION STANDARD 0700001

Alpha Technologies Ltd.

7700 Riverfront Gate
Burnaby, BC V5J 5M4
Canada
Tel: +1 604 436 5900
Fax: +1 604 436 1233
Toll Free: +1 800 667 8743
www.alpha.ca

Alpha Energy

1628 W Williams Drive
Phoenix, AZ 85027
United States
Tel: +1 623 251 3000
Fax: +1 623 249 7833
www.alphaenergy.us

Alphatec Ltd.

339 St. Andrews St.
Suite 101 Andrea Chambers
P.O. Box 56468
3307 Limassol, Cyprus
Tel: +357 25 375 675
Fax: +357 25 359 595
www.alpha.com

Alpha Innovations S.A.

1, Avenue Alexander Fleming
B-1348 Ottignies, Louvain-la-Neuve
Belgium
Tel: +32 10 438 510
Fax: +32 10 438 213
www.alphainnovations.eu

Alpha Technologies Turkey Enerji Ltd Sti

Altaycesme Mah. Sarigul Sok. No: 33 Umut Kent
Sistesi A Blok D:5
Maltepe, Istanbul
Turkey
Tel: +90 216 370 23 28
Fax: +90 216 370 23 68
www.alpha.com.tr

Alpha Technologies Inc.

3767 Alpha Way
Bellingham, WA 98226
United States
Tel: +1 360 647 2360
Fax: +1 360 671 4936
www.alpha.com

Alpha Technologies GmbH.

Hansastrasse 8
91126
Schwabach, Germany
Tel: +49 9122 79889 0
Fax: +49 9122 79889 21
www.alphatechnologies.com

Alpha Technologies Pty Ltd.

Level 7
91 Phillip Street
Parramatta NSW 2150
Australia
Tel: +61 2 8599 6960
www.alpha.com

OutBack Power

17825 59th Ave. NE, Suite B
Arlington, WA 98223
United States
Tel: +1 360 435 6030
Fax: +1 360 435 6019
www.outbackpower.com

Alpha Mexico Network Power S.A. de C.V.

Calle Dakota #204, of 303, Col. Nápoles.
México D.F. C.P.03810, México
Tel: +55 5543 1114
Toll Free: +01 800 0082 886
www.alphapower.mx

Alpha Industrial Power Inc.

1075 Satellite Blvd NW.
Suite 400
Suwanee, GA 30024
Tel: +1 678 475 3995
Fax: +1 678 584 9259
www.alpha.com

Alpha Technologies Europe Ltd.

Twyford House, Thorley
Bishop's Stortford
Hertfordshire, CM22 7PA
United Kingdom
Tel: +44 1279 501110
Fax: +44 1279 659870
www.alphatechnologies.com

Alpha Innovations Brasil

Address: Rua Alvares Cabral,
Nº 338 – Diadema - SP
09981-030
Brazil
Tel: +55 11 2476 0150
www.alphainnovations.com.br

Alpha Tec Trading Co. Ltd.

Suite 1903, Tower 1,
China Hong Kong City,
33 Canton Road,
Kowloon, Hong Kong
Tel: +852 2736 8663
Fax: +852 2199 7988
www.alpha.com

NavSemi Technologies Pvt Ltd.

Vikas Plaza, Plot No. 38/1A (4),
Electronic City Phase 2, Hosur Road,
Bengaluru – 560100, Karnataka, India.
Tel: +91 80 4123 0299
www.navsemi.com

Alpha Technologies Ltd.



member of The  Group™

Due to continuing product development, Alpha Technologies reserves the right to change specifications without notice.
Copyright © 2018 Alpha Technologies. All Rights Reserved. Alpha® is a registered trademark of Alpha Technologies.

0100003-J0 (07/2018)